

HI WAISTED PANTS
STYLE: PANTS
SAMPLE SIZE: 8
1ST SAMPLE NOT APPROVED
ATTENDING FIT:
DEBORAH BEARD
TATIANA GRANDE
ALEKSANDRA ZANUIKA

Dear manager. Please see the fit comments and pictures bellow. Make changens according to comments and pattern corrections

1. Pocket is too small. Increase and reshape.
See picture and pattern correction.
2. SS SHIFTED TO TOWARDS BACK MOVE TOWARD FRONT BY 1/2".
SEE PATTERN CORRECTION
3. MAKE POCKET PERPENDICULAR TO CROTCH SEAM
4. BACK RISE IS TOO SHORT. INCREASE ACORDING TO PATTERN
CORRECTION ATTACHED
5. BACK RISE IS TOO SHALLOW. INCREASE AND RESHAPE.
SEE PATTERN CORRECTIONS PAGE
6. ZIPPER OPENING IS TOO LONG. MAKE 1" SMALLER
(TO ACCOMODATE 6"ZIPPER)

Tech Pack Type Apparel
No of Item(s) 2
Style No 1BT0802
Description
Style Category Bottoms
Size Range 0 - 20
Size Class Missy

Garment Wash/Treatment
Tech-Pack Due 10/11/2017
Status In Progress
Design Contact
Tech Design Contact
Sourcing Contact

Owner
Active Yes
Created By GRANDE TATIANA
Created Date 10/9/2017
Modified By GRANDE TATIANA
Modified Date 10/13/2017

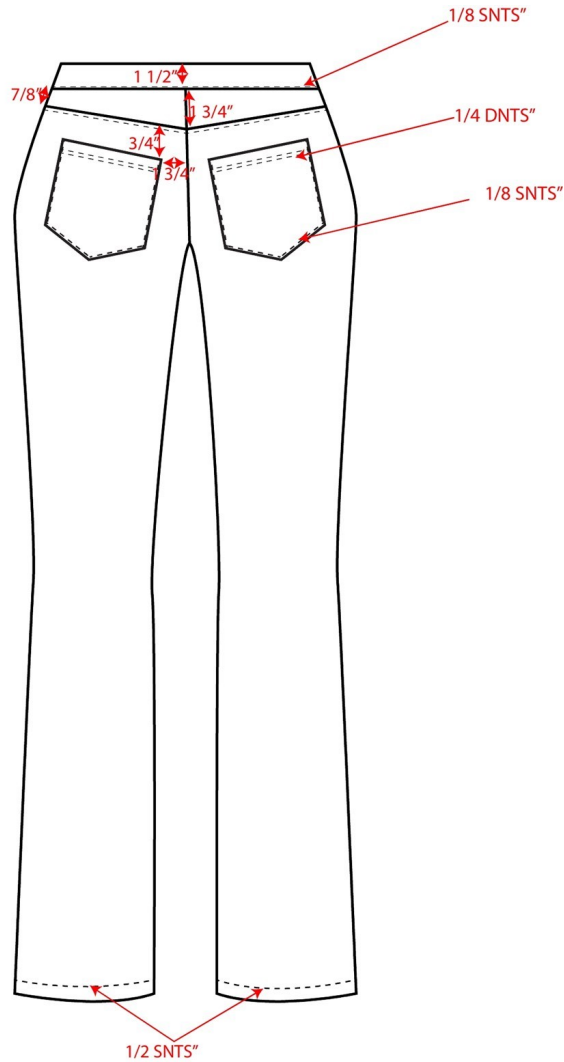
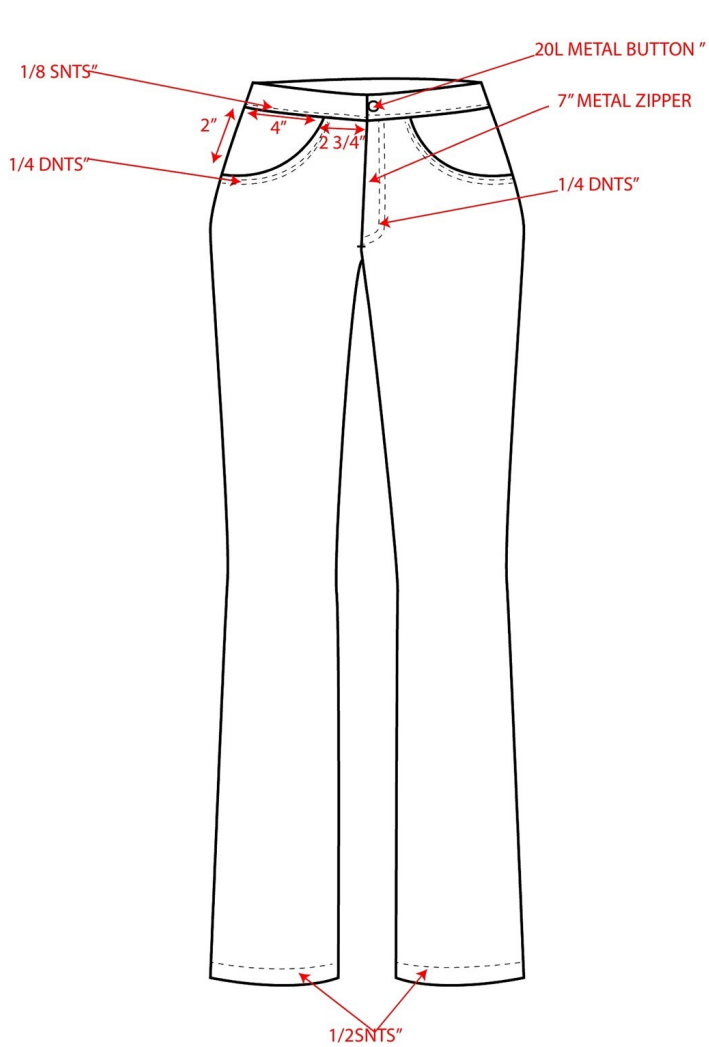

Style Type	Apparel	Garment Wash/Treatment		Owner	
No of Item(s)	2	Tech-Pack Due	10/11/2017	Division	
Style No	1BT0802	Status	In Progress	Active	Yes
Description		Design Contact		Created By	GRANDE TATIANA
Style Category	Bottoms	Tech Design Contact		Created Date	10/9/2017
Size Range	0 - 20	Sourcing Contact		Modified By	GRANDE TATIANA
Size Class	Missy			Modified Date	10/13/2017

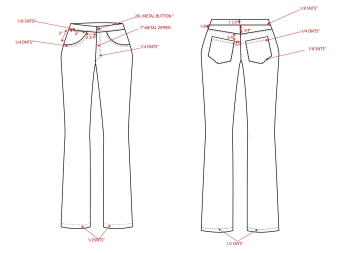

Comments **Modified By**

Front

Back

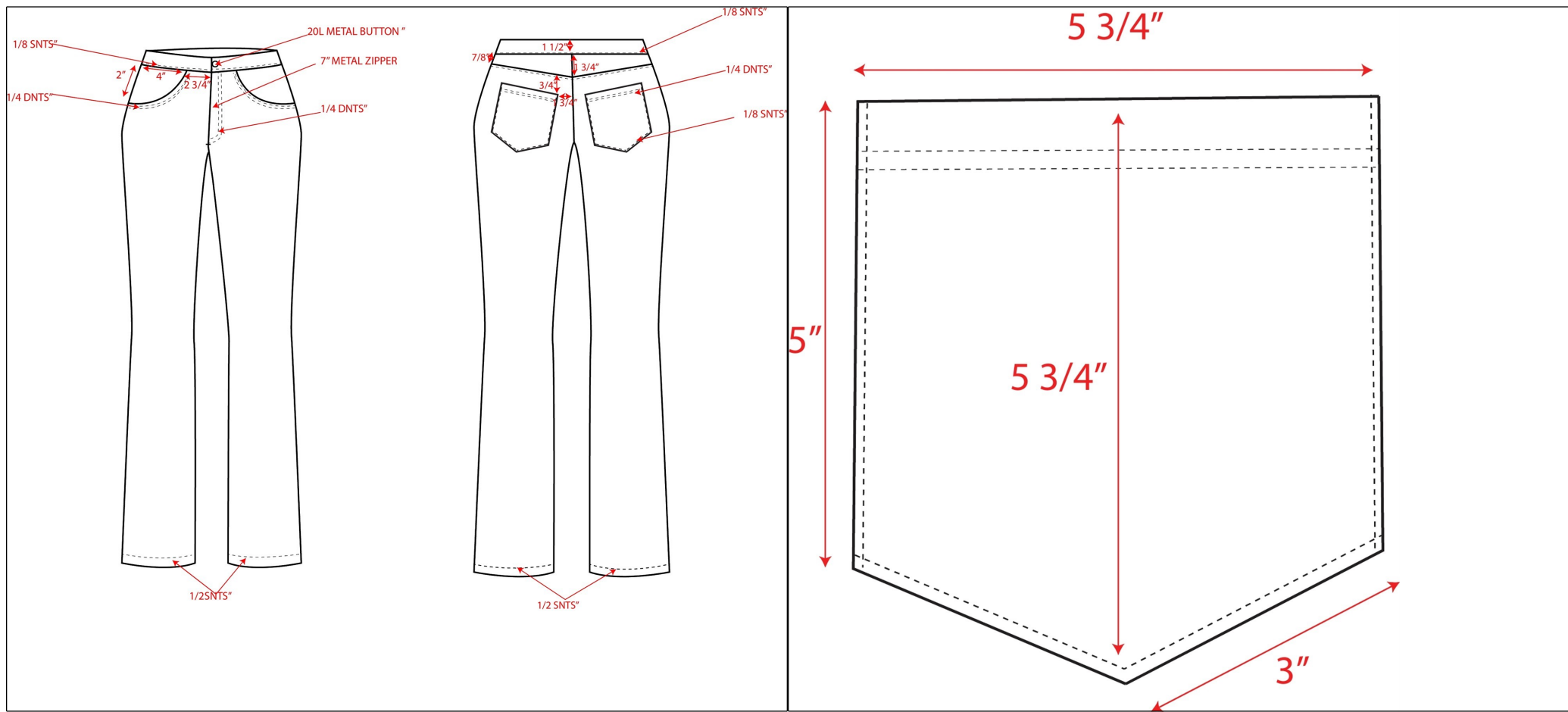

Style Type	Apparel	Garment Wash/Treatment		Owner	
No of Item(s)	2	Tech-Pack Due	10/11/2017	Division	
Style No	1BT0802	Status	In Progress	Active	Yes
Description		Design Contact		Created By	GRANDE TATIANA
Style Category	Bottoms	Tech Design Contact		Created Date	10/9/2017
Size Range	0 - 20	Sourcing Contact		Modified By	GRANDE TATIANA
Size Class	Missy			Modified Date	10/13/2017

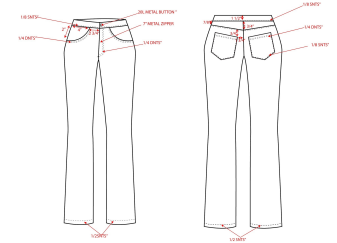

Modified By	Comments
-------------	----------



FABRIC: 100% COTTON
BLACK AND WHITE PRINT

1BT0802

Style Type	Apparel	Garment Wash/Treatment		Owner	
No of Item(s)	2	Tech-Pack Due	10/11/2017	Division	
Style No	1BT0802	Status	In Progress	Active	Yes
Description		Design Contact		Created By	GRANDE TATIANA
Style Category	Bottoms	Tech Design Contact		Created Date	10/9/2017
Size Range	0 - 20	Sourcing Contact		Modified By	GRANDE TATIANA
Size Class	Missy			Modified Date	10/13/2017

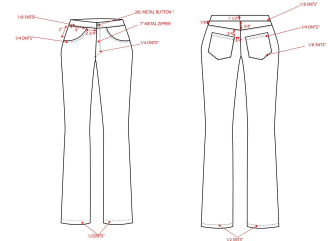

Modified By	Comments
-------------	----------

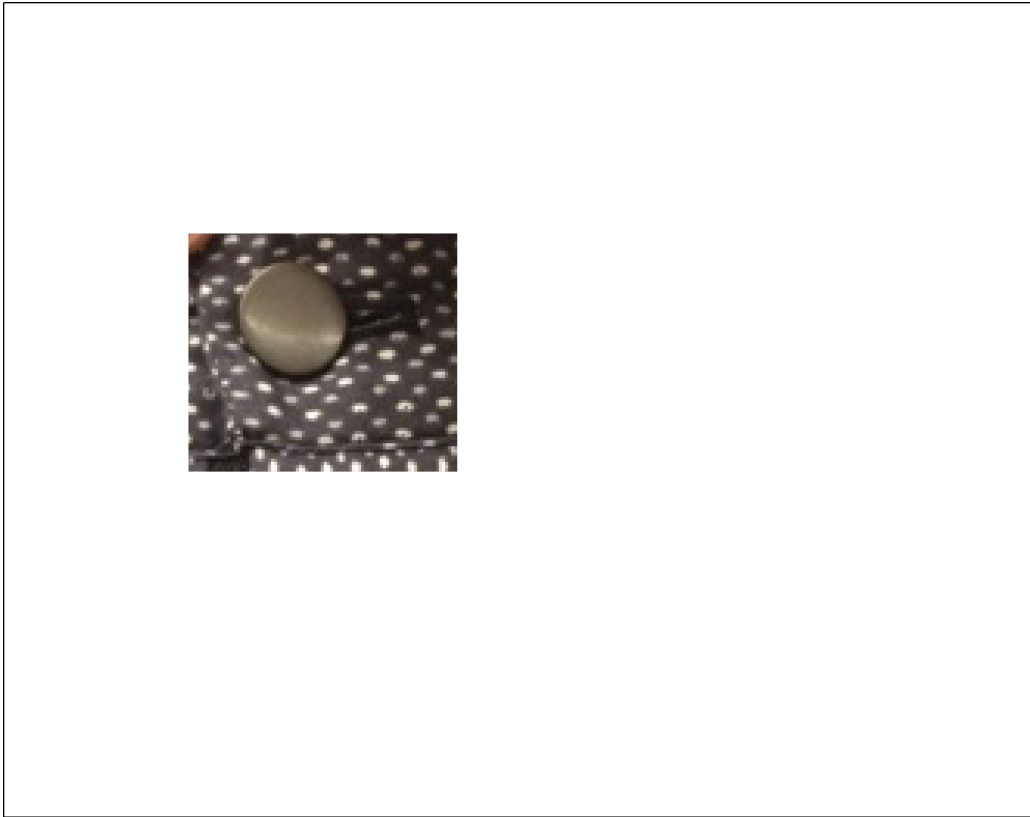

TRIM:
1 20L METAL BUTTON

1BT0802

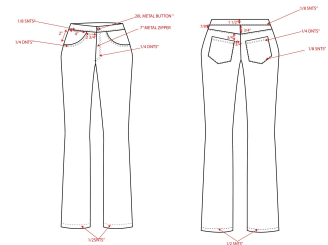

Style Type	Apparel	Garment Wash/Treatment		Owner	
No of Item(s)	2	Tech-Pack Due	10/11/2017	Division	
Style No	1BT0802	Status	In Progress	Active	Yes
Description		Design Contact		Created By	GRANDE TATIANA
Style Category	Bottoms	Tech Design Contact		Created Date	10/9/2017
Size Range	0 - 20	Sourcing Contact		Modified By	GRANDE TATIANA
Size Class	Missy			Modified Date	10/13/2017

Product Type	Pant	Size Class	Womens	Sample Size	6
Description	Skinny Leg Women's Pant	Size Range	0 - 20	Method-System	Relative - Imperial

POM	Description	+Tol	-Tol	0	2	4	6	8	10	12	14	16	18	20
178	Bottom Opening - Half	1/8	-1/8	5 3/4	6	6 1/4	6 1/2	6 3/4	7	7 1/4	7 1/2	7 3/4	6 3/4	6 3/4
183	Front Rise	1/8	-1/8	10 3/4	11	11 1/4	11 1/2	11 3/4	12	12 1/4	12 1/2	12 3/4	11 3/4	11 3/4
184	Back Rise BB	1/8	-1/8	12 3/4	13	13 1/4	13 1/2	13 3/4	14	14 1/4	14 1/2	14 3/4	13 3/4	13 3/4
187	Outseam - BB- Full	0	0	0	0	0	0	0	0	0	0	0	0	0
188	Inseam Full	1/8	-1/8	29	30	31	32	33	34	35	36	37	33	33
194	Zipper/ Fly	1/8	-1/8	5 3/4	6	6 1/4	6 1/2	6 3/4	7	7 1/4	7 1/2	7 3/4	6 3/4	6 3/4
195	Width of J-Stitch	1/8	-1/8	-3/4	-1/2	-1/4	0	1/4	1/2	3/4	1	1 1/4	1/4	1/4
195	Width of J-Stitch	1/8	-1/8	-3/4	-1/2	-1/4	0	1/4	1/2	3/4	1	1 1/4	1/4	1/4
220	Waist Relaxed	1/8	-1/8	11 1/2	12 1/2	13 1/2	14 1/2	15 1/2	16 1/2	17 1/2	18 1/2	19 1/2	15 1/2	15 1/2
220B	Waist Extended	1/8	-1/8	-3	-2	-1	0	1	2	3	4	5	1	1
223	High Hip	1/8	-1/8	15 1/4	16 1/4	17 1/4	18 1/4	19 1/4	19 1/2	19 3/4	20	20 1/4	19 1/4	19 1/4
224	HIP	1/8	-1/8	16 1/2	17 1/2	18 1/2	19 1/2	20 1/2	20 3/4	21	21 1/4	21 1/2	20 1/2	20 1/2
276	Thigh	1/8	-1/8	11	11 1/4	11 1/2	11 3/4	12	12 1/4	12 1/2	12 3/4	13	12	12
278	Bottom Opening - Full	1/8	-1/8	-3/4	-1/2	-1/4	0	1/4	1/2	3/4	1	1 1/4	1/4	1/4
306	Waistband Height	1/8	-1/8	1 1/2	1 1/2	1 1/2	1 1/2	1 1/2	1 1/2	1 1/2	1 1/2	1 1/2	1 1/2	1 1/2

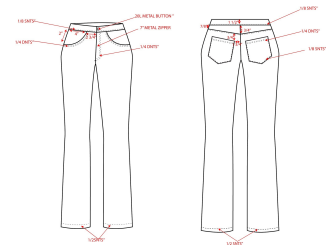

Style Type	Apparel	Garment Wash/Treatment		Owner	
No of Item(s)	2	Tech-Pack Due	10/11/2017	Division	
Style No	1BT0802	Status	In Progress	Active	Yes
Description		Design Contact		Created By	GRANDE TATIANA
Style Category	Bottoms	Tech Design Contact		Created Date	10/9/2017
Size Range	0 - 20	Sourcing Contact		Modified By	GRANDE TATIANA
Size Class	Missy			Modified Date	10/13/2017

Product Type	JD WOVEN PANT XS-XL	Size Class	Missy	Sample Size	8
Description	HIGH WAIST RUFFLE PANTS	Size Range	0 - 20	Method-System	Relative - Imperial

POM	Description	+Tol	-Tol	0	2	4	6	8	10	12	14	16	18	20
JD000	WAIST CIRCUMFERENCE ALONG TOP EDGE	1/2	-1/2	-4	-3	-2	-1	0	1	2 1/2	4	5 1/2	7	8 1/2
JD001	WAIST CIRC. ALONG SEAM	1/2	-1/2	-4	-3	-2	-1	0	1	2 1/2	4	5 1/2	7	8 1/2
JD002	WAIST BAND HEIGHT	1/8	-1/8	0	0	0	0	0	0	0	0	0	0	0
JD003	FRONT RISE LENGTH	1/4	-1/4	-1 1/2	-1 1/8	-3/4	-3/8	0	3/8	7/8	1 7/8	2 3/8	2 7/8	3 3/8
JD004	BACK RISE LENGTH	1/4	-1/4	-1 1/2	-1 1/8	-3/4	-3/8	0	3/8	7/8	1 7/8	2 3/8	2 7/8	3 3/8
JD005	HIP CIRCUMFERENCE POSITION	0	0	-1/2	-3/8	-1/4	-1/8	0	1/8	1/4	3/8	1/2	5/8	3/4
JD006	HIP CIRCUMFERENCE	1/2	-1/2	-4	-3	-2	-1	0	1	2 1/2	4	5 1/2	7	8 1/2
JD007	THIGH CIRCUMFERENCE	1/4	-1/4	-3	-2 1/4	-1 1/2	-3/4	0	3/4	1 1/2	2 1/2	3 1/2	4 1/2	0
JD008	KNEE CIRCUMFERENCE	1/4	-1/4	-1 1/2	-1 1/8	-3/4	-3/8	0	3/8	7/8	1 3/8	1 7/8	2 3/8	2 7/8
JD009	LEG OPENING CIRCUMFERENCE	1/4	-1/4	-1 1/2	-1 1/8	-3/4	-3/8	0	3/8	7/8	1 3/8	1 7/8	2 3/8	2 7/8
JD010	INSEAM LENGTH	1/2	-1/2	0	0	0	0	0	0	0	0	0	0	0
JD011	FLY OR ZIPPER OPENING LENGTH	1/4	-1/4	-1/2	-1/2	-1/2	0	0	0	1/2	1/2	1	1	1
JD012	FLY TOPSTITCH WIDTH	1/8	-1/8	0	0	0	0	0	0	0	0	0	0	0
JD013	FRONT POCKET PLACEMENT ALONG WAIST SEAM	1/8	-1/8	-1/2	-3/8	-1/4	-1/8	0	1/8	1/4	3/8	1/2	5/8	3/4
JD014	FRONT PKT PLACEMENT ALONG SIDE SEAM	1/8	-1/8	-1/2	-3/8	-1/4	-1/8	0	1/8	1/4	3/8	1/2	5/8	3/4
JD015	BESOM OPENING LENGTH	1/4	-1/4	-1/2	-3/8	-1/4	-1/8	0	1/8	1/4	3/8	1/2	5/8	0
JD016	POCKET BESOM WIDTH	0	0	0	0	0	0	0	0	0	0	0	0	0

Style Type	Apparel	Garment Wash/Treatment		Owner	
No of Item(s)	2	Tech-Pack Due	10/11/2017	Division	
Style No	1BT0802	Status	In Progress	Active	Yes
Description		Design Contact		Created By	GRANDE TATIANA
Style Category	Bottoms	Tech Design Contact		Created Date	10/9/2017
Size Range	0 - 20	Sourcing Contact		Modified By	GRANDE TATIANA
Size Class	Missy			Modified Date	10/13/2017

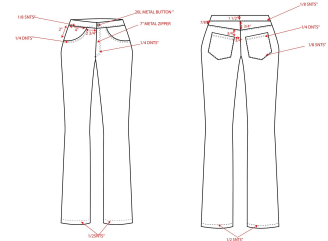

Product Type	JD WOVEN PANT XS-XL	Size Class	Missy	Sample Size	8
Description	HIGH WAIST RUFFLE PANTS	Size Range	0 - 20	Method-System	Relative - Imperial

POM	Description	+Tol	-Tol	0	2	4	6	8	10	12	14	16	18	20
JD017	POCKET LENGTH AT CENTER	1/8	-1/8	-1/2	-3/8	-1/4	-1/8	0	1/8	1/4	3/8	1/2	5/8	3/4
JD018	POCKET LENGTH AT SIDE	1/8	-1/8	-1/2	-3/8	-1/4	-1/8	0	1/8	1/4	3/8	1/2	5/8	3/4
JD019	PATCH POCKET LENGTH ALONG TOP EDGE	1/8	-1/8	-1/2	-3/8	-1/4	-1/8	0	1/8	1/4	3/8	1/2	5/8	3/4
JD020	HEM TURNBACK WIDTH	1/8	-1/8	0	0	0	0	0	0	0	0	0	0	0
JD021	BELT LOOP WIDTH	0	0	0	0	0	0	0	0	0	0	0	0	0
JD022	BELT LOOP LENGTH	1/8	-1/8	0	0	0	0	0	0	0	0	0	0	0

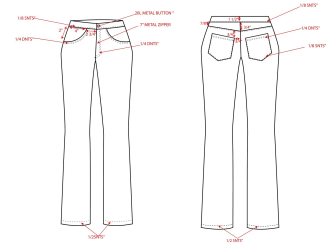

Style Type	Apparel	Garment Wash/Treatment		Owner	
No of Item(s)	2	Tech-Pack Due	10/11/2017	Division	
Style No	1BT0802	Status	In Progress	Active	Yes
Description		Design Contact		Created By	GRANDE TATIANA
Style Category	Bottoms	Tech Design Contact		Created Date	10/9/2017
Size Range	0 - 20	Sourcing Contact		Modified By	GRANDE TATIANA
Size Class	Missy			Modified Date	10/13/2017



Back



Front



Side

1BT0802

Style Type	Apparel	Garment Wash/Treatment		Owner	
No of Item(s)	2	Tech-Pack Due	10/11/2017	Division	
Style No	1BT0802	Status	In Progress	Active	Yes
Description		Design Contact		Created By	GRANDE TATIANA
Style Category	Bottoms	Tech Design Contact		Created Date	10/9/2017
Size Range	0 - 20	Sourcing Contact		Modified By	GRANDE TATIANA
Size Class	Missy			Modified Date	10/13/2017

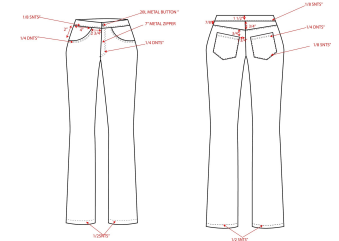

Modified By	Comments
-------------	----------

1. Pocket is too small. Increase and reshape. See picture and pattern correction.



1. PKT TOO SMALL. INCREASE AND RESHAPE. SEE PATTERN CORRECTION PAGE.

1BT0802

Style Type	Apparel	Garment Wash/Treatment		Owner	
No of Item(s)	2	Tech-Pack Due	10/11/2017	Division	
Style No	1BT0802	Status	In Progress	Active	Yes
Description		Design Contact		Created By	GRANDE TATIANA
Style Category	Bottoms	Tech Design Contact		Created Date	10/9/2017
Size Range	0 - 20	Sourcing Contact		Modified By	GRANDE TATIANA
Size Class	Missy			Modified Date	10/13/2017

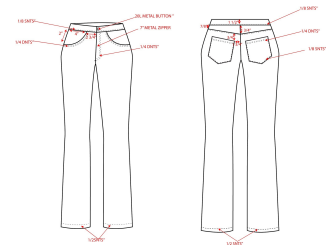

Modified By	Comments
-------------	----------



2. SS SHIFTED TO TOWARDS BACK MOVE TOWARD FRONT BY 1/2". SEE PATTERN CORRECTION

3. MAKE POCKET PERPENDICULAR TO CROTCH SEAM

2. SS SHIFTED. MOVE TOWARDS FRT BY 1/2". SEE PATTERN CORRECTIONS PAGE
3. MAKE BK PKT PERPENDICULAR TO CROTCH SEAM

1BT0802

Style Type	Apparel	Garment Wash/Treatment		Owner	
No of Item(s)	2	Tech-Pack Due	10/11/2017	Division	
Style No	1BT0802	Status	In Progress	Active	Yes
Description		Design Contact		Created By	GRANDE TATIANA
Style Category	Bottoms	Tech Design Contact		Created Date	10/9/2017
Size Range	0 - 20	Sourcing Contact		Modified By	GRANDE TATIANA
Size Class	Missy			Modified Date	10/13/2017

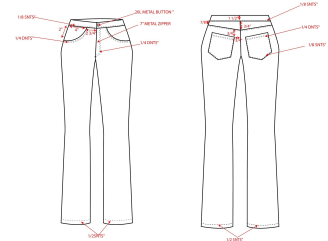

Modified By	Comments
-------------	----------

4. BACK RISE IS TOO SHORT. INCREASE ACORDING TO PATTERN CORRECTION ATTACHED



4. BK RISE IS TOO SHORT. INCREASE ACCORDING TO PATTERN CORRECTION ATTACHED

5. BK RISE IS TOO SHALLOW. INCREASE AND RESHAPE. SEE PATTERN CORRECTION PAGE.

5. BACK RISE IS TOO SHALLOW. INCREASE AND RESHAPE. SEE PATTERN CORRECTIONS PAGE

1BT0802

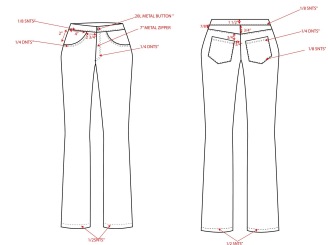

Style Type	Apparel	Garment Wash/Treatment		Owner	
No of Item(s)	2	Tech-Pack Due	10/11/2017	Division	
Style No	1BT0802	Status	In Progress	Active	Yes
Description		Design Contact		Created By	GRANDE TATIANA
Style Category	Bottoms	Tech Design Contact		Created Date	10/9/2017
Size Range	0 - 20	Sourcing Contact		Modified By	GRANDE TATIANA
Size Class	Missy			Modified Date	10/13/2017

Modified By	Comments
-------------	----------



6. ZIPPER OPNG TOO LONG. DECREASE TO ACCOMMODATE 6" ZIPPER

ZIPPER OPENING IS TOO LONG. MAKE 1" SMALLER (TO ACCOMODATE 6"ZIPPER)

1BT0802

Style Type	Apparel	Garment Wash/Treatment		Owner	
No of Item(s)	2	Tech-Pack Due	10/11/2017	Division	
Style No	1BT0802	Status	In Progress	Active	Yes
Description		Design Contact		Created By	GRANDE TATIANA
Style Category	Bottoms	Tech Design Contact		Created Date	10/9/2017
Size Range	0 - 20	Sourcing Contact		Modified By	GRANDE TATIANA
Size Class	Missy			Modified Date	10/13/2017

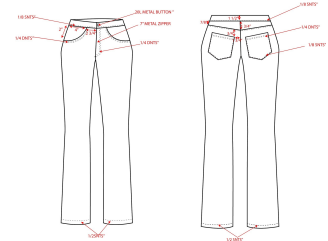

Modified By	Comments	
<p>HI WAISTED PANTS STYLE: PANTS SAMPLE SIZE: 8 1ST SAMPLE NOT APPROVED ATTENDING FIT: DEBORAH BEARD TATIANA GRANDE ALEKSANDRA ZANUIKA</p>	<ol style="list-style-type: none"> 1. Pocket is too small. Increase and reshape. See picture and pattern correction. 2. SS SHIFTED TO TOWARDS BACK MOVE TOWARD FRONT BY 1/2". SEE PATTERN CORRECTION 3. MAKE POCKET PERPENDICULAR TO CROTCH SEAM 4. BACK RISE IS TOO SHORT. INCREASE ACORDING TO PATTERN CORRECTION ATTACHED 5. BACK RISE IS TOO SHALLOW. INCREASE AND RESHAPE. SEE PATTERN CORRECTIONS PAGE 6. ZIPPER OPENING IS TOO LONG. MAKE 1" SMALLER (TO ACCOMODATE 6"ZIPPER) 	<p>FIRST FIT CORRECTIONS AND COMMENTS</p> <ol style="list-style-type: none"> 1. PKT TOO SNMALL. INCREASE AND RESHAPE. SEE PICTURE AND PATTERN CORR PAGE. 2.SS SHITING TOWARD BACK. MOVE TOWARDS FRT. SEE PATTERN CORR PAGE. 3.MAKE PKT PERPRNDICULAR TI CROTCH SEAM. 4.BK RISE IS TOO SHORT. INCREASE ACCORDING TO PATTERN CORR PAGE 5.BK RISE IS TOO SHALLOW. INCREASE AND RESHAPE. SEE PATTERN CORR PAGE. 6. ZIPPER OPNG IS TOO LONG. MAKE SHORTER TO ACCOMMODATE 6" ZIPPER
1BT0802		

H WAISTED PANTS
STYLE: PANTS
SAMPLE SIZE: 8
2 SAMPLE NOT APPROVED
ATTENDING FIT:
DEBORAH BEARD
TATIANA GRANDE
ALEKSANDRA ZANUIKA

Dear manager. Please see the fit comments and pictures bellow. Make changens according to comments and pattern corrections

1. 1 2 .
- 2.
3. M 1 1 2
4. 1 2 . .
5. . .

Style Type	Apparel	Garment Wash/Treatment		Owner	
No of Item(s)	2	Tech-Pack Due	10/11/2017	Division	
Style No	1BT0802	Status	In Progress	Active	Yes
Description		Design Contact		Created By	GRANDE TATIANA
Style Category	Bottoms	Tech Design Contact		Created Date	10/9/2017
Size Range	0 - 20	Sourcing Contact		Modified By	GRANDE TATIANA
Size Class	Missy			Modified Date	10/13/2017

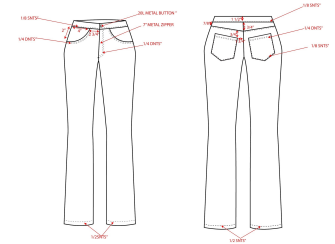

Modified By	Comments
-------------	----------



FABRIC: 100% COTTON

1BT0802

Style Type	Apparel	Garment Wash/Treatment		Owner	
No of Item(s)	2	Tech-Pack Due	10/11/2017	Division	
Style No	1BT0802	Status	In Progress	Active	Yes
Description		Design Contact		Created By	GRANDE TATIANA
Style Category	Bottoms	Tech Design Contact		Created Date	10/9/2017
Size Range	0 - 20	Sourcing Contact		Modified By	GRANDE TATIANA
Size Class	Missy			Modified Date	10/13/2017

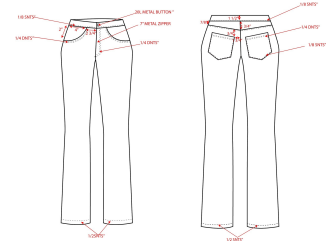

Modified By	Comments
-------------	----------

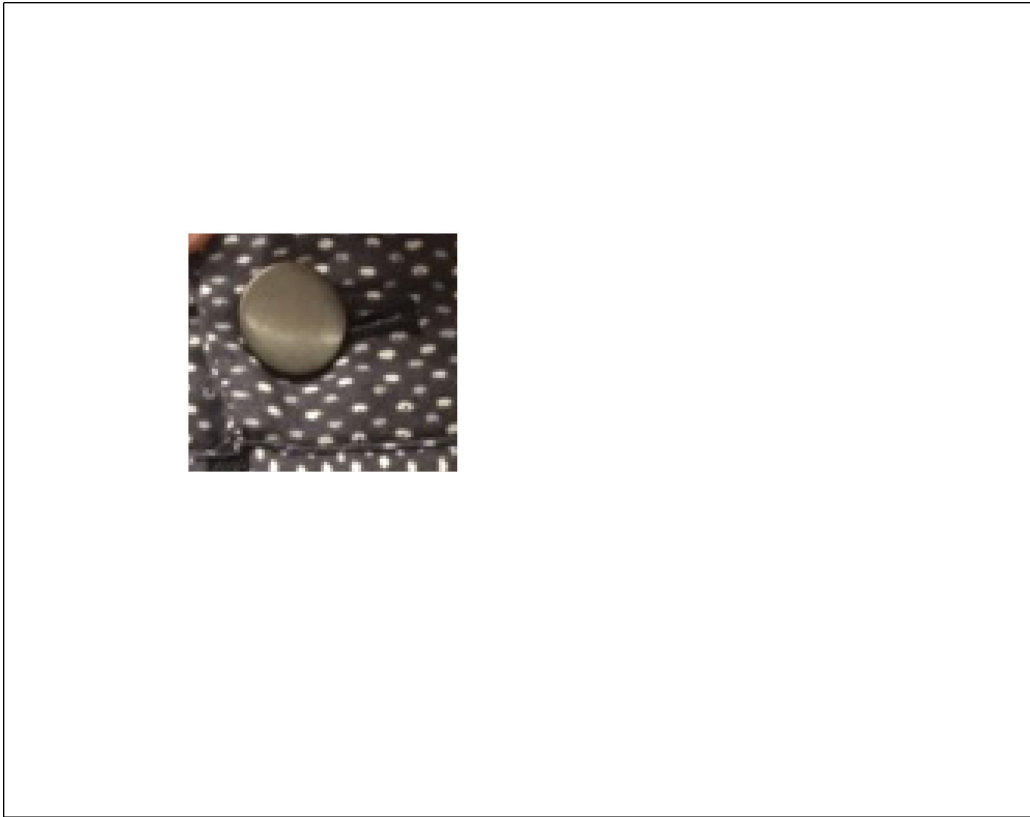

BUTTON: 20L METAL BUTTON

1BT0802

Style Type	Apparel	Garment Wash/Treatment		Owner	
No of Item(s)	2	Tech-Pack Due	10/11/2017	Division	
Style No	1BT0802	Status	In Progress	Active	Yes
Description		Design Contact		Created By	GRANDE TATIANA
Style Category	Bottoms	Tech Design Contact		Created Date	10/9/2017
Size Range	0 - 20	Sourcing Contact		Modified By	GRANDE TATIANA
Size Class	Missy			Modified Date	10/13/2017

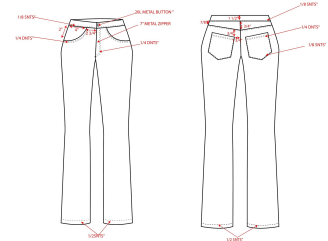

Modified By	Comments
-------------	----------



1. REDUCE WB AT TOP BY 1/2. PATTERN CORRECTIONS

1. REDUCE WB AT TOP BY 1/2" SEE PATTERN CORRECTION

1BT0802

Style Type	Apparel	Garment Wash/Treatment		Owner	
No of Item(s)	2	Tech-Pack Due	10/11/2017	Division	
Style No	1BT0802	Status	In Progress	Active	Yes
Description		Design Contact		Created By	GRANDE TATIANA
Style Category	Bottoms	Tech Design Contact		Created Date	10/9/2017
Size Range	0 - 20	Sourcing Contact		Modified By	GRANDE TATIANA
Size Class	Missy			Modified Date	10/13/2017

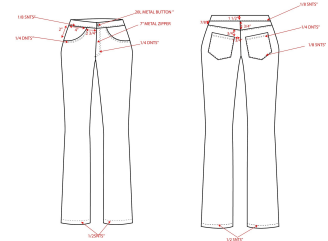

Modified By	Comments
-------------	----------

2. MAKE YOLK 7/8 AT SS

2. MAKE YOLK 1/5" AT CB



- 2. MAKE YOLK 7/8" AT SS
- 3. MAKE YOLK 1 1/2 AT CB

1BT0802

Style Type	Apparel	Garment Wash/Treatment		Owner	
No of Item(s)	2	Tech-Pack Due	10/11/2017	Division	
Style No	1BT0802	Status	In Progress	Active	Yes
Description		Design Contact		Created By	GRANDE TATIANA
Style Category	Bottoms	Tech Design Contact		Created Date	10/9/2017
Size Range	0 - 20	Sourcing Contact		Modified By	GRANDE TATIANA
Size Class	Missy			Modified Date	10/13/2017

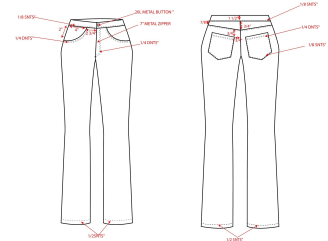

Modified By	Comments
-------------	----------

5. REDUCE AT WIDTH AT KNEE AREA SEE PATTERN CORRECTION



5. BULK AT KNEE. REDUCE WIDTH AT KNEE AREA. PATTERN CORRECTIONS.

1BT0802

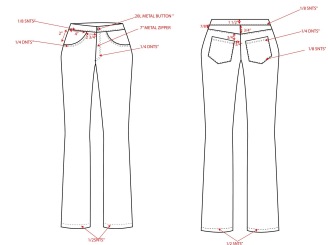

Style Type	Apparel	Garment Wash/Treatment		Owner	
No of Item(s)	2	Tech-Pack Due	10/11/2017	Division	
Style No	1BT0802	Status	In Progress	Active	Yes
Description		Design Contact		Created By	GRANDE TATIANA
Style Category	Bottoms	Tech Design Contact		Created Date	10/9/2017
Size Range	0 - 20	Sourcing Contact		Modified By	GRANDE TATIANA
Size Class	Missy			Modified Date	10/13/2017

Modified By	Comments
<p>HI WAISTED PANTS STYLE: PANTS SAMPLE SIZE: 8 2ST SAMPLE NOT APPROVED ATTENDING FIT: DEBORAH BEARD TATIANA GRANDE ALEKSANDRA ZANUIKA</p>	<p>2ND FIT CORRECTIONS AND COMMENTS</p> <ol style="list-style-type: none"> 1. REDUCE WB AT TOP BY 1/2" SEE PATTERN CORRECTION 2. MAKE YOLK 7/8 AT SS 2. MAKE YOLK 1 1/2" AT CB 4. MAKE POCKET OPENING 1/2" SMALLER AT SS 5. REDUCE AT WIDTH AT KNEE AREA SEE PATTERN CORRECTION
1BT0802	

Style Type	Apparel	Garment Wash/Treatment		Owner	
No of Item(s)	2	Tech-Pack Due	10/11/2017	Division	
Style No	1BT0802	Status	In Progress	Active	Yes
Description		Design Contact		Created By	GRANDE TATIANA
Style Category	Bottoms	Tech Design Contact		Created Date	10/9/2017
Size Range	0 - 20	Sourcing Contact		Modified By	GRANDE TATIANA
Size Class	Missy			Modified Date	10/13/2017

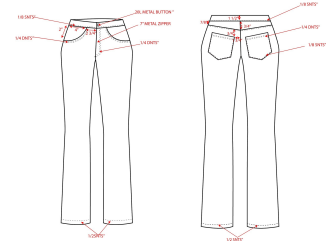

Product Type	Pant	Size Class	Womens	Sample Size	6
Description	Skinny Leg Women's Pant	Size Range	0 - 20	Method-System	Relative - Imperial

POM	Description	+Tol	-Tol	0	2	4	6	8	10	12	14	16	18	20
178	Bottom Opening - Half	1/8	-1/8	5 7/8	6 1/8	6 3/8	6 5/8	6 7/8	7 1/8	7 3/8	7 5/8	7 7/8	6 7/8	6 7/8
183	Front Rise	1/8	-1/8	10 1/4	10 1/2	10 3/4	11	11 1/4	11 1/2	11 3/4	12	12 1/4	11 1/4	11 1/4
184	Back Rise BB	1/8	-1/8	11	11 1/4	11 1/2	11 3/4	12	12 1/4	12 1/2	12 3/4	13	12	12
187	Outseam - BB- Full	1/8	-1/8	-3	-2	-1	0	1	2	3	4	5	1	1
188	Inseam Full	1/8	-1/8	29	30	31	32	33	34	35	36	37	33	33
194	Zipper/ Fly	1/8	-1/8	5 1/4	5 1/2	5 3/4	6	6 1/4	6 1/2	6 3/4	7	7 1/4	6 1/4	6 1/4
195	Width of J-Stitch	1/8	-1/8	-3/4	-1/2	-1/4	0	1/4	1/2	3/4	1	1 1/4	1/4	1/4
195	Width of J-Stitch	1/8	-1/8	1/4	1/2	3/4	1	1 1/4	1 1/2	1 3/4	2	2 1/4	1 1/4	1 1/4
220	Waist Relaxed	1/8	-1/8	12	13	14	15	16	17	18	19	20	16	16
220B	Waist Extended	1/8	-1/8	-3	-2	-1	0	1	2	3	4	5	1	1
223	High Hip	1/8	-1/8	15	16	17	18	19	19 1/4	19 1/2	19 3/4	20	19	19
224	HIP	1/8	-1/8	-3	-2	-1	0	1	1 1/4	1 1/2	1 3/4	2	1	1
276	Thigh	1/8	-1/8	-3/4	-1/2	-1/4	0	1/4	1/2	3/4	1	1 1/4	1/4	1/4
278	Bottom Opening - Full	1/8	-1/8	-3/4	-1/2	-1/4	0	1/4	1/2	3/4	1	1 1/4	1/4	1/4
306	Waistband Height	1/8	-1/8	0	0	0	0	0	0	0	0	0	0	0

Style Type	Apparel	Garment Wash/Treatment		Owner	
No of Item(s)	2	Tech-Pack Due	10/11/2017	Division	
Style No	1BT0802	Status	In Progress	Active	Yes
Description		Design Contact		Created By	GRANDE TATIANA
Style Category	Bottoms	Tech Design Contact		Created Date	10/9/2017
Size Range	0 - 20	Sourcing Contact		Modified By	GRANDE TATIANA
Size Class	Missy			Modified Date	10/13/2017

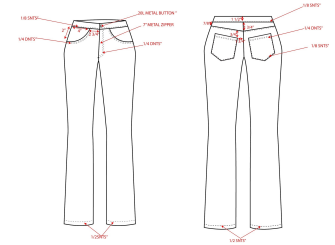

Modified By	Comments
-------------	----------

Style Type	Apparel	Garment Wash/Treatment		Owner	
No of Item(s)	2	Tech-Pack Due	10/11/2017	Division	
Style No	1BT0802	Status	In Progress	Active	Yes
Description		Design Contact		Created By	GRANDE TATIANA
Style Category	Bottoms	Tech Design Contact		Created Date	10/9/2017
Size Range	0 - 20	Sourcing Contact		Modified By	GRANDE TATIANA
Size Class	Missy			Modified Date	10/13/2017

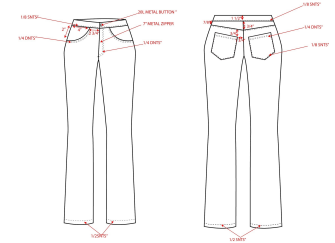

1BT0802

Style Type	Apparel	Garment Wash/Treatment		Owner	
No of Item(s)	2	Tech-Pack Due	10/11/2017	Division	
Style No	1BT0802	Status	In Progress	Active	Yes
Description		Design Contact		Created By	GRANDE TATIANA
Style Category	Bottoms	Tech Design Contact		Created Date	10/9/2017
Size Range	0 - 20	Sourcing Contact		Modified By	GRANDE TATIANA
Size Class	Missy			Modified Date	10/13/2017

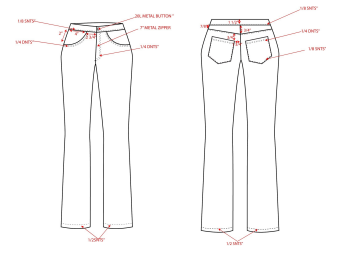

Comments **Modified By**

Front

Back

